

Data Sheet

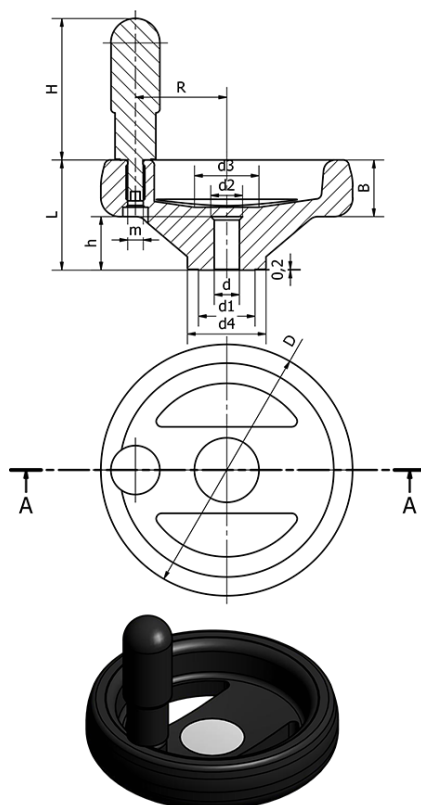

Article number: 2301079311R
Description: E+G Handwheel
VRTP.200-P+I-SST-16
Note: Plastic

Measures



= -	d H7	= 16
B = 28	H	= 34
Code = 79311-R	L	= 61
D = 200	R	= 84
d1 = 30	Type	= VRTP.200-P+I-SST-16
d2 = 28	Weight (g)	= 552
d3 = 36		
d4 = 50		